



## Process-driven collaboration support for intra-agency crime analysis

J. Leon Zhao<sup>a,\*</sup>, Henry H. Bi<sup>c</sup>, Hsinchun Chen<sup>a</sup>, Daniel D. Zeng<sup>a</sup>,  
Chienting Lin<sup>d</sup>, Michael Chau<sup>b</sup>

<sup>a</sup>MIS Department, University of Arizona, Tucson, Arizona 85721, USA

<sup>b</sup>School of Business, The University of Hong Kong, Pokfulam Road, Hong Kong

<sup>c</sup>Department of Supply Chain and Information Systems, Pennsylvania State University, University Park, PA 16802, USA

<sup>d</sup>School of CSIS, Pace University, 1 Pace Plaza, New York, NY 10038, USA

Available online 1 September 2004

### Abstract

In law enforcement applications, there is a critical need for new tools that can facilitate efficient and effective collaboration. Through a field study, we observe that crime analysis, a critical component of law enforcement operations, is knowledge intensive and often involves collaborative efforts from multiple law enforcement officers within and across agencies. To better facilitate such knowledge intensive collaboration and thereby improve law enforcement agencies' crime-fighting capabilities, we propose a novel methodology based on modeling and implementation techniques from workflow management and information retrieval. This paper presents this process-driven collaboration methodology and its prototype implementation as part of an integrated law enforcement information management environment called COPLINK.

© 2004 Elsevier B.V. All rights reserved.

*Keywords:* Collaborative workflow; Crime analysis; Collaboration support systems; Law enforcement applications

### 1. Introduction

In response to the September 11 terrorist attacks, major government efforts, including the recent establishment of the Department of Homeland Security, to modernize law enforcement agencies' intelligence

collection and processing capabilities have been initiated to strengthen public safety and security.

Previous studies have shown that law enforcement activities are knowledge intensive and information processing systems play a critical role in police organizations [15]. It is estimated that police officers spend up to 40% of their time handling information, making it one of the most extensive police activities [12]. As such, the primary emphasis for information technology in the law enforcement context is on "increasing applied, useful and succinct information" [10].

\* Corresponding author.

*E-mail addresses:* [lzhao@eller.arizona.edu](mailto:lzhao@eller.arizona.edu) (J.L. Zhao), [henrybi@psu.edu](mailto:henrybi@psu.edu) (H.H. Bi), [hchen@eller.arizona.edu](mailto:hchen@eller.arizona.edu) (H. Chen), [zeng@eller.arizona.edu](mailto:zeng@eller.arizona.edu) (D.D. Zeng), [linc@eller.arizona.edu](mailto:linc@eller.arizona.edu) (C. Lin), [mchau@business.hku.hk](mailto:mchau@business.hku.hk) (M. Chau).

Most existing crime recording, analysis and investigation systems focus on information storage and retrieval. Some of the recently developed police information systems start to make use of data mining techniques for automatically detecting crime patterns [1]. Although these systems serve indispensable functions and represent major advantages over the previous-generation of non-computer-based police records approach, we argue that there is a critical need to develop additional technologies facilitating the efficient flow of information and documents throughout various stages of law enforcement and enabling collaboration among law enforcement officers working on related cases. It has been identified in previous research that many detection failures in police work are due to the fact that the necessary information is either not received by police or lost or distorted within the police system, especially when criminals are increasingly mobile [18].

To the best of our knowledge, little research has been reported on how to effectively manage such information flow and related collaborative processes within law enforcement agencies from a technological perspective [9,17]. Research reported in this paper is intended to fill in this important gap. Based on the observations obtained from a field study involving a medium-sized metropolitan police agency, we identify specific collaboration and process facilitation requirements in intra-agency crime analysis and then propose a process-driven collaboration support framework based on workflow technology, which has been developed to streamline and automate business processes [16]. Recently, new workflow paradigms have been developed to support flexible process automation in the context of non-conventional workflow environment. For instance, the Metis workflow technology are designed for use in digital libraries to support highly distributed sets of stakeholders who nevertheless must work together to perform shared activities [2]. The Metis approach makes use of event-based workflows to support the distributed nature of digital library workflow and employs techniques to make the resulting technology lightweight, flexible and integrated with the Web.

To avoid confusion, we first define several key terms including collaboration, collaboration process and collaboration support in the crime-fighting context. By collaboration, we mean that law enforcement

officers working on the same crime case share information and contribute expertise and time to solve the crime. Collaboration process refers to the sequence of actions, some of them in the information processing realm, taken by law enforcement officers that might have direct or indirect impact on officers working on the same cases. By collaboration support, we refer to the automated functions provided by the crime analysis system that facilitate the collaboration process. Examples of such functions include searching automatically relevant cases, identifying the appropriate collaborators and facilitating the interactions among collaborators.

The rest of the paper is organized as follows. Section 2 summarizes characteristics of the crime analysis process and identifies the needs for better process-driven collaboration support. The discussions in this section are based on a field study involving a medium-size police agency. Section 3 presents a conceptual model of collaboration process for intra-agency crime analysis using the representation tools and techniques from workflow technology. In Section 4, we discuss system architecture issues related to the development of a workflow-based collaboration support system and present a prototype implementation of the proposed framework as part of an integrated law enforcement information management environment, called COPLINK. We conclude the paper in Section 5 by summarizing our research contributions and pointing out future research directions.

## 2. Characteristics of crime analysis process: a field study

In this section, we summarize the characteristics of typical crime analysis processes, based on a field study we conducted in a medium-size police department. Our main observation is that the crime analysis process is dynamic and complex and involves a large number of formal documents of various types. This observation leads to a new design of collaborative support for crime analysis based on the workflow management framework, presented in later sections.

### 2.1. A field study

We conducted a field study from summer 2001 to summer 2002 in a medium-size metropolitan police

department to gain in-depth, hands-on knowledge about crime analysis. Typically, there are three main types of law officers directly involved in fighting crimes in a police department: patrol officers, crime analysts and detectives. These three types of law enforcement officers belong to their respective functional departments or units. Crime analysts and detectives are often further organized into groups in their departments according to crime types so that each officer can specialize in one or a small number of areas. The field study was conducted in four stages:

- Stage 1 Interviews and general discussions. During this stage, we interviewed six police officers including two crime analysts, two detectives and two patrol officers, for about 2 h. This unstructured interview helped us understand the needs for crime analysis, the major tasks of these three types of law enforcement officers and the relationships among different police units.
- Stage 2 Surveys. On the basis of the outputs of stage 1 and the functional analysis documents of the police department, we sent questionnaires via emails to the six police officers interviewed in stage 1 to solicit generic information about their work processes. They sent questionnaires back via emails. From this survey, we understood the work stages of each type of police officers and the people, information, inputs and outputs involved in each stage.
- Stage 3 Focused interview and discussions. After understanding their general work processes, we used structured questions to interview these six law enforcement officers again for about one hour each. This focused interview emphasized on understanding how police officers collect, record, retrieve, share and analyze information and how they collaborate during their work processes. We identified the problems in the current practice and found ways to improve and automate the current processes.
- Stage 4 Observation on work processes of crime analysts. Because crime analysis is of primary interest in our study, we spent half

a day on observing how a crime analyst receives requests, works on both simple and complex cases and reports results. This first-hand observation helped us better understand the work of crime analysts and confirm the general findings obtained from surveys and interviews.

Note that, when conducting this field study, we had another detective assigned to our project, with whom we interacted almost on a daily basis for several weeks. Such an intensive pilot study enabled us to conclude the above four-stage field study in a short period of time.

In terms of workflow, the crime analysis and investigation process can be decomposed into the following five stages.

- (1) Collecting crime data at crime scenes. When a crime occurs, patrol officers and detectives usually work at the crime scene to collect and record crime information in various documents. Various means of information collection methods are used in this stage including ongoing questioning of victims, witnesses and suspects.
- (2) Processing and filing crime data and documents. Crime reports and related documents are then collected and managed by a special information and document processing unit inside the police department and part of the recorded information is entered into one or more computer-based records management systems.
- (3) Searching, retrieving and collecting additional information. When investigating a case, detectives and crime analysts often need to seek information about the suspects and crime from various data resources and databases beyond what was collected at the crime scene. For instance, after a detective is assigned a case, he or she may individually search for needed information or ask a crime analyst to help. Information sources used in this stage include records from various organizations ranging from related police departments, public utility companies (e.g., water, gas and electric), phone companies and various city, state and federal government branches.

- (4) Analyzing information to find leads. After additional information is collected, detectives or crime analysts often employ various techniques to try to identify linkages among criminals and among crimes, locate additional clues and synthesize leads to prepare for evidence to be used in prosecution. Such analysis techniques include crime pattern analysis, various data mining and association techniques, among others [6]. When a crime analyst completes the analysis in response to a request from a detective, he or she must prepare a report summarizing the results of the analysis. Often such reports are delivered to the requesting detective in a hardcopy and not recorded in any computerized systems.
- (5) Using collected and synthesized information to prosecute criminals. Detectives and crime analysts need to compile and post-process the crime information collected in the above four stages to generate formal documents necessary for prosecuting criminals. In addition, detectives may need to perform many data intensive tasks such as completing supplemental reports, requesting lab reports from crime laboratory technicians, and obtaining transcripts of all interviews from transcribers. Furthermore, this stage often involves collaboration of detectives from several departmental units, and staff from the county attorney's office and the courts to combine all the information into a complete file that becomes the basis for the prosecution.

These five stages are usually conducted in sequence; in some cases, they may be interwoven and conducted in an iterative manner. For instance, findings from information analysis at stage 4 may relate one gang of interest to another, thus motivating detectives or crime analysts to return to stage 3 to collect new information about the latter.

## 2.2. The need for collaboration support

The above summary and analysis based on field observations reveal several deficiencies in current crime analysis and investigation practices:

- (1) When crime analysts or detectives needs information about a case, they often have to search

many disparate data resources and then piece together scattered information. For instance, it is common to search four or five different systems to collect information on a given person of interest or address [1].

- (2) The current crime analysis and investigation process is largely manual-driven involving a large amount of documentation routed by law enforcement officers themselves. Different units and organizations (e.g., record unit internal to a policy agency and different courts) require different document formats. There exists significant overlaps and duplications in those documents, resulting in wasted resources and the difficulty of keeping data sources updated and consistent among each other.
- (3) Many cases may be related to each other (e.g., a narcotics case may be connected to a homicide case). However, they are often assigned to different crime analysts and detectives according to certain case characteristics such as general crime type. This is especially true when connections among cases are yet to be uncovered in earlier stages of crime analysis. As a result, while many criminals and crime organizations commit various types of crimes in multiple physical locations during different periods of times, crime analysis and investigation fail to recognize the connections, hindering crime-fighting. Successful collaboration within and between law enforcement agencies is needed to uncover these connections and help fight these crimes effectively.

These three types of deficiencies in crime analysis point to a great need for process automation in collaboration support. A process-driven collaboration support system can improve the efficiency of police work by linking various databases flexibly, automating the data collection process, standardizing and automatically creating and routing various forms, and revealing relationships among various crime cases. In this paper, we investigate a workflow technology-based solution to support collaborative crime analysis within a police department. Our approach also provides a technological foundation to enable collaboration across law enforcement agencies.

### 3. A conceptual model of collaboration process for crime analysis

In this section, we study intra-agency crime analysis as a process management problem. Our goal is to identify the key types of collaborations in crime analysis and develop process-driven collaboration support mechanisms.

#### 3.1. Crime analysis as a collaboration process

Illustrated in Fig. 1 is a typical collaboration process in a law enforcement agency, where three main types of law enforcement officers work together to resolve crime cases. Patrol officers often are the first to get in contact with a crime case by responding to incident requests. They collect crime information, make arrests if needed and file incident reports to the record unit within the police department. If the case requires further investigation, the case is handed to an appropriate detective. The detective will then review the available reports, pursue further research and prepare a detective report after necessary interviews with victims and suspects if any. While the detective researches the case, a crime analyst might be asked to

conduct in-depth research on the case if extensive information search and case analysis are needed.

In Fig. 1, the patrol officer process and detective process are shown to be sequential, and the crime analyst process is depicted as a possible subprocess in the detective process. In practice, these processes could be iterative or conducted in parallel. For instance, while the crime analyst is working on researching the case, the detective could proceed to certain interviews that are not dependent on the crime analyst's result.

In order to design an automated or semi-automated approach to facilitate crime analysis processes, it is necessary to create a formal representation of such processes for the purposes of both modeling and providing computational support. We use activity-based workflow modeling notations proposed in [5] to formally represent templates of crime analysis processes. These notations are shown in Fig. 2. In activity-based workflow modeling, there are two types of nodes, activity nodes that represent activities and routing nodes that route the execution flows of activities. There are two special activity nodes: the start activity node representing the start point of the workflow and the end activity node standing for the

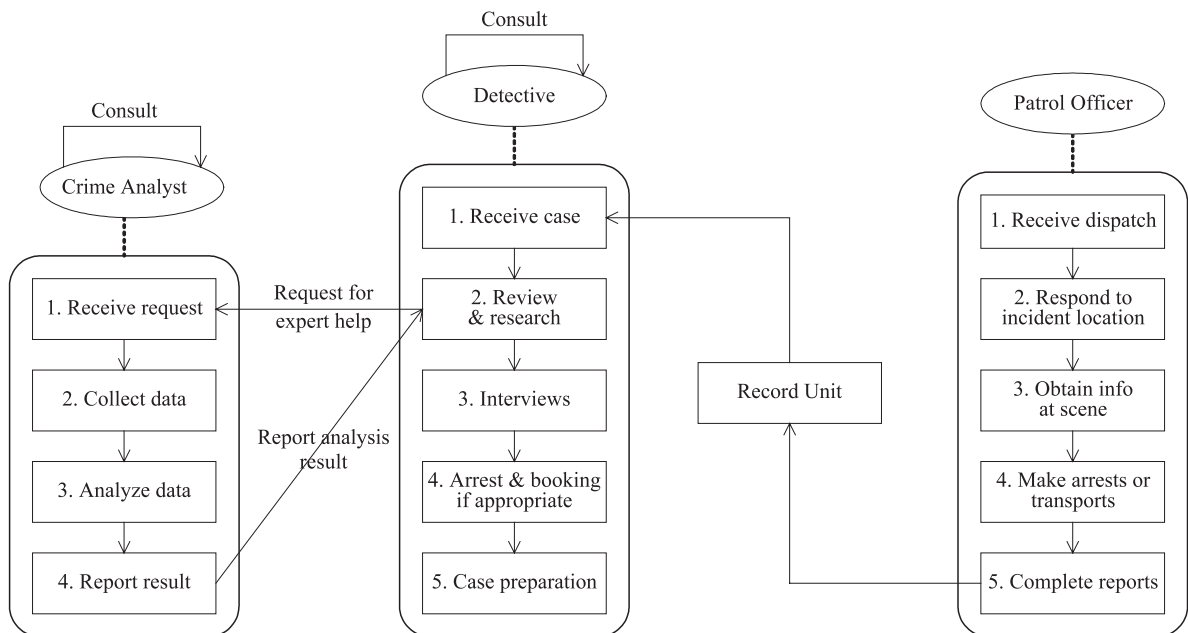

Fig. 1. Collaborative processes in a law enforcement agency.



Fig. 2. Notations of activity-based workflow modeling.

end point. There are three kinds of routing nodes, AND node, OR node and XOR node. Activities linked to an AND node should all be executed. For activities that are linked to an XOR node, only one of them is executed. For activities that are linked to an OR node, one or more of them may be executed, depending on the scenarios. Finally, directed arcs are used to link nodes.

Fig. 3 illustrates a typical crime analysis process involving patrol officers, detective sergeants, detectives and crime analysts. To simplify the process, the whole process is shown as four subprocesses, patrol officer process, detective sergeant process, detective process and crime analyst process. The subprocesses are linked to one another at the corresponding circled numbers. Note that we are not trying to model all existing processes in a police department, but rather to show some existing processes (based on our field study findings) as an indication of the complexity of law enforcement processes.

### 3.2. Scenarios and support mechanisms of crime analysis collaboration

We now categorize the key crime analysis scenarios in which collaboration plays an important role. Furthermore, for each of these scenarios, we develop a conceptual design of the corresponding collaboration support mechanism.

- Find an appropriate crime analyst based on a given case. Crime analysts are generally organized according to crime types, but a requester (usually a detective) can submit a request for a detailed crime analysis on a given case to any analyst, sometimes based on personal relationship. Thus, a requester may approach a crime analyst who is not the best suited analyst for the requested job. A potential collaboration support is to help the requester identify the most appropriate crime analyst for researching the given case. This would require the knowledge about the crime analysts in terms of their history of crime analyses and the technique for matching the given case to crime analysts.
- Collaborative data collection and analysis. Usually, a crime analyst collects and analyzes data for a case independently of other agents. However, finding connections among different cases require lots of experience, insights and efforts, thus it can be very time consuming. A potential collaboration support is to deploy collaboration mechanisms such that data collection and analysis for a given case can build on similar cases that have occurred previously. This can be done by implementing a backend search process based on the given case to reveal the data searched or used by other agents on similar cases.
- Enriched dispatch information. Typically, when an officer receives a dispatch to a scene, little historical and related information is provided with the dispatch about the incident location, previous cases, people, etc. A collaboration support can provide such relevant information. Providing this support requires automated searches based on the dispatch information.
- Automated report clustering. When a patrol officer submits a completed report to the detective, the report is deposited to the record unit. If the report is done electronically, the information should be entered into a standard form. Then, the report should be automatically clustered with existing reports in order to find potential matches and clues for crime investigation.
- Find the appropriate detectives for a case. In most cases, a unit sergeant assigns a case to a detective based on crime type and his or her experience with similar cases. In a small police department, the unit sergeant knows all detectives and can do the assignment fairly well. In a large police department, however, an automated search tool for the suitable detectives will improve the quality of case assignment and result in the improvement of the overall efficiency of the police department.

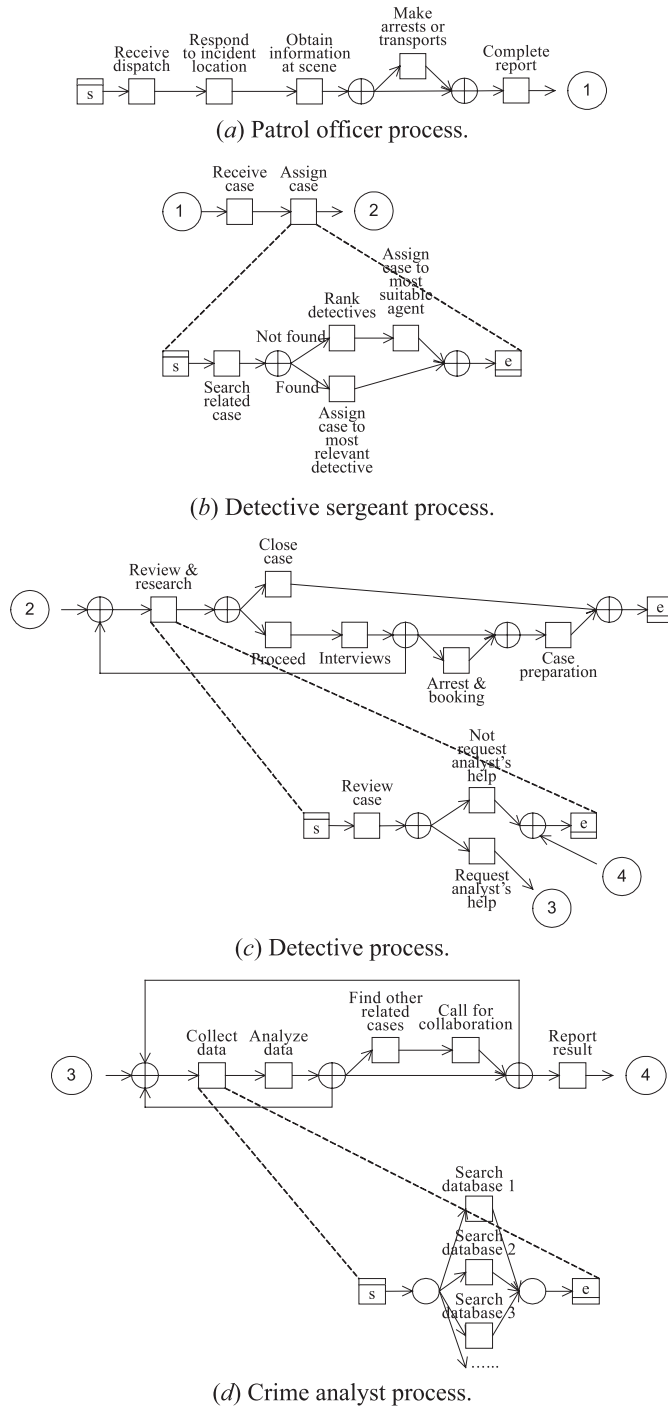

Fig. 3. Detailed law enforcement processes.

- Advanced search for interviewees. During an investigation that may take years, a detective interviews victims, witnesses, suspects and/or arrestees on an ongoing basis. Finding connections between the newly obtained information to the same case and other cases requires lots of experience, insights and efforts. A case-based search tool will be very useful for comparing updated case information with existing crime-related people in order to assist detectives find potential interviewees.

The collaboration scenarios and the corresponding support mechanisms discussed above all have to do with assisting law enforcement officers to determine the most appropriate resources, including people and cases, via advanced searching techniques. Table 1 illustrates the research issues related to the development of collaboration support mechanisms.

There are two important technical issues associated with the development of these support mechanisms. First, the advanced search techniques require further research and development to find suitable algorithms with sufficient precision since law enforcement is very sensitive and the accuracy of search results can have legal consequences. Second, the search initialization requires novel techniques, particularly when the search

is triggered by certain events and the parameters need to be set up with the assistance of the involved officers.

### 3.3. Workflow models of crime analysis collaboration

In Table 1, a number of potential collaboration workflows are identified such as consultation workflow, task assignment and negotiation workflow, task monitoring workflow and case alert workflow. These workflows are based on typical collaborative interaction patterns and can be used to reduce the workload in collaboration interactions by automating many lower-level collaboration-related tasks, and enhance the collaboration experience by capturing the collaboration results and integrating with knowledge management tools [4]. Before presenting conceptual designs of these workflows, we briefly justify the use of workflow technology in the context of facilitating collaborative efforts in crime analysis.

Past research and industry experience have shown that the key to develop flexible and maintainable information systems is to maintain data independence and process independence [19]. *Data independence* is a measure of the robustness of software systems when the data structures are modified. Relational database became dominant in the database market, mainly because it achieved significant data independence.

Table 1  
Summary of collaboration types, example activities and techniques

Types	Example activities	Sample techniques
Expert consulting	A junior detective wants to consult a senior detective with relevant experiences but does not know whom to consult with. A detective needs to get information from a crime analyst but does not know the most appropriate persons to contact.	Provide a standard consulting form. Search and rank the relevant personnel based on past cases solved or general experiences. Automatically initiate contact with the potential consultants with the relevant information. Initiate a consultation workflow with the experts.
Task assignment	A sergeant wants to assign a high-profile case to a detective but is unsure about who is the most suitable. A detective wants to assign a case to a crime analyst but does not sure which one to assign to assure expertise and prompt turnaround time.	Provide a customizable search form based on the case description and other parameters the sergeant can choose. Search and rank the relevant personnel based on the case and parameters provided. Start negotiation workflows with potential assignees so that the most suitable person will get the job. Determine the assignee by the sergeant or the detective. Initiate an assignment monitoring workflow with the assignee.
Case alerting	When a new or existing case is considered to be critical and urgent, the case should be made known to knowledgeable personnel based on their past experiences. But, it is not efficient to flood everyone with too much information.	Announce the case with high-level description so that people can come forward on their own. Match the given case with all cases to discover law enforcement personnel who have had similar experiences. Initiate a case alert workflow with those personnel.

*Process independence* is a measure of the robustness of software systems when the process model is redesigned. The drive towards more process independence has led to the proliferation of workflow systems in the software industry in the last few years. Workflow technology helps achieve software flexibility by modeling processes explicitly and managing business processes as data that are much easier to modify than conventional program modules. A workflow management systems enable reuse of process templates, robust integration of enterprise applications and flexible coordination of human agents and teams, making it ideally suitable for law enforcement applications such as collaborative crime analysis.

We now discuss the conceptual designs of the workflows identified in the previous subsection.

- Consultation workflow. Once an officer identifies one or more experts to consult with, the officer would initiate contact with these experts and follow through with the interactions. Each consultation could go through a process of raising the question, clarifying details in the question, passing the expert opinion, issuing additional inquiries and finally wrapping up the consultation. Since multiple experts might be consulted, a parallel process

should occur. Furthermore, the experts might interact with each other during the consultation process to exchange the ideas and experiences. Since this process might be time consuming if done manually, a consultation workflow can be used to reduce the tediousness of the process, help capture the results of the consultation, and enhance the impact of the consultation by providing knowledge management tools. Fig. 4 illustrates the typical steps of a consultation workflow, including parallel interactions with multiple experts and possible interactions between experts. The upper part of a consultation workflow involves mainly the consultant(s) and the lower part the requester.

- Take assignment and negotiation workflow. Once a sergeant identifies one or more potential assignees, he or she might want to negotiate with the detectives or assignees in order to select the most suitable. Possible topics of negotiation might include the assignee's opinion on the suitability of the task, the current workload of the assignee and the assignee's plan to accomplish the task. The negotiation process might be helpful in boosting the overall morale of the unit, better utilizing the talent and ensuring the speedy resolution of the case. Fig. 5 illustrates the negotiation workflow that includes the confirmation

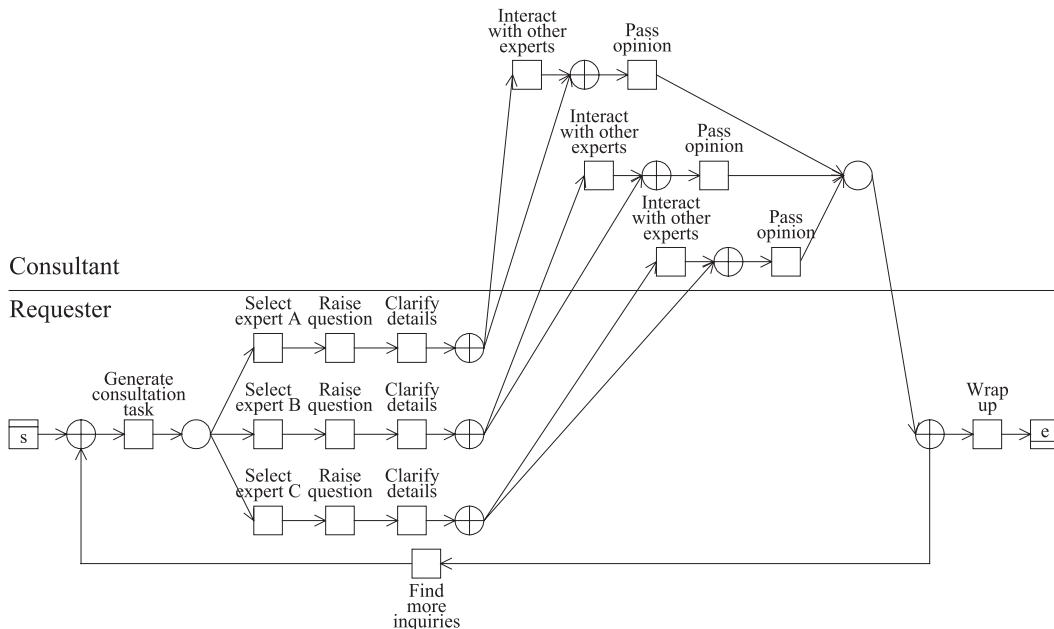

Fig. 4. Consultation workflow.

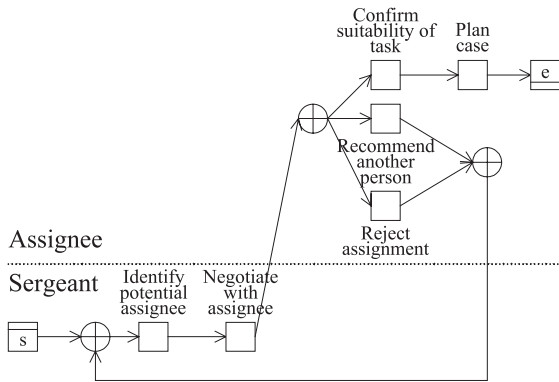

Fig. 5. Task negotiation workflow.

by the assignee on the suitability of the task, interacting with the sergeant on the planning of the case and possibly recommending another person for the task when the potential assignee is reluctant to take on the case. The upper part of the workflow contains the activities by the detective and the lower part consists of the activities by the sergeant.

- Case alert workflow. When the list of most relevant personnel is identified with respect to a case, a case alert workflow can be initiated. This workflow includes such steps as forwarding case details to each person on the list, requesting for comments from these people, initiating discussions among those on the list, identifying special interest groups related to the case, commenting on the case in terms of strategies, tactics, clues and other information. Fig. 6 illustrates the workflow model of case alert.

#### 4. COPLINK workflow—a process-driven collaboration support system for crime analysis

We have implemented a prototype crime analysis system, called COPLINK workflow (short for COPLINK Collaboration workflow), embodying the principles and design considerations discussed in the previous two sections. This system is implemented as part of the COPLINK system, an integrated law enforcement information and knowledge management environment developed by the University of Arizona Artificial Intelligence Laboratory in collaboration with the Tucson Police Department and the Phoenix Police Department [6]. COPLINK workflow is the third module of the COPLINK system. The other two

main modules are COPLINK Connect, which allows diverse police departments to share data seamlessly through an easy-to-use interface that integrates different data sources including legacy record management systems, and COPLINK Detect, which helps uncover various types of criminal associations that exist in police databases using advanced data mining and clustering techniques. COPLINK workflow leverages COPLINK Connect and Detect for access to crime data and associations needed for various types of case matching discussed in the previous section.

Consistent with the architecture of COPLINK Connect and Detect, COPLINK workflow was implemented as a Web-based distributed database access and collaboration system. The main development platform was based on the standard three-tier Web architecture: JavaServer Pages/HTML/JavaScript for the front end, Java Beans for middleware and business logic implementation, and relational database for data store. Database monitoring and maintenance functions in COPLINK workflow was implemented using database triggers in Oracle DBMS. Any database changes of interest, such as insert, update, delete operations, will fire the associated trigger which in turn will proactively execute the required workflows. The data repository used by COPLINK workflow has a total of 1.5 million police records. In terms of database schema, this data repository contains 217 tables and over 1000 attributes. The following sections briefly present the COPLINK workflow’s system architecture, its main functions, as well as the main findings of evaluating COPLINK workflow in real law enforcement practice.

##### 4.1. Overview of the system architecture

COPLINK workflow’s system architecture is shown in Fig. 7. It consists of a Web-based workflow user interface and four functional modules, namely the searching and monitoring module, the collaboration module, the alerting module and the process execution module. The searching and monitoring module is responsible for retrieving records from the database,

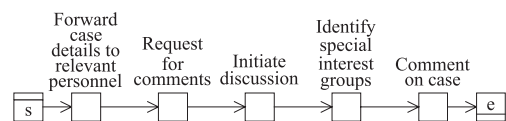

Fig. 6. Case alert workflow.

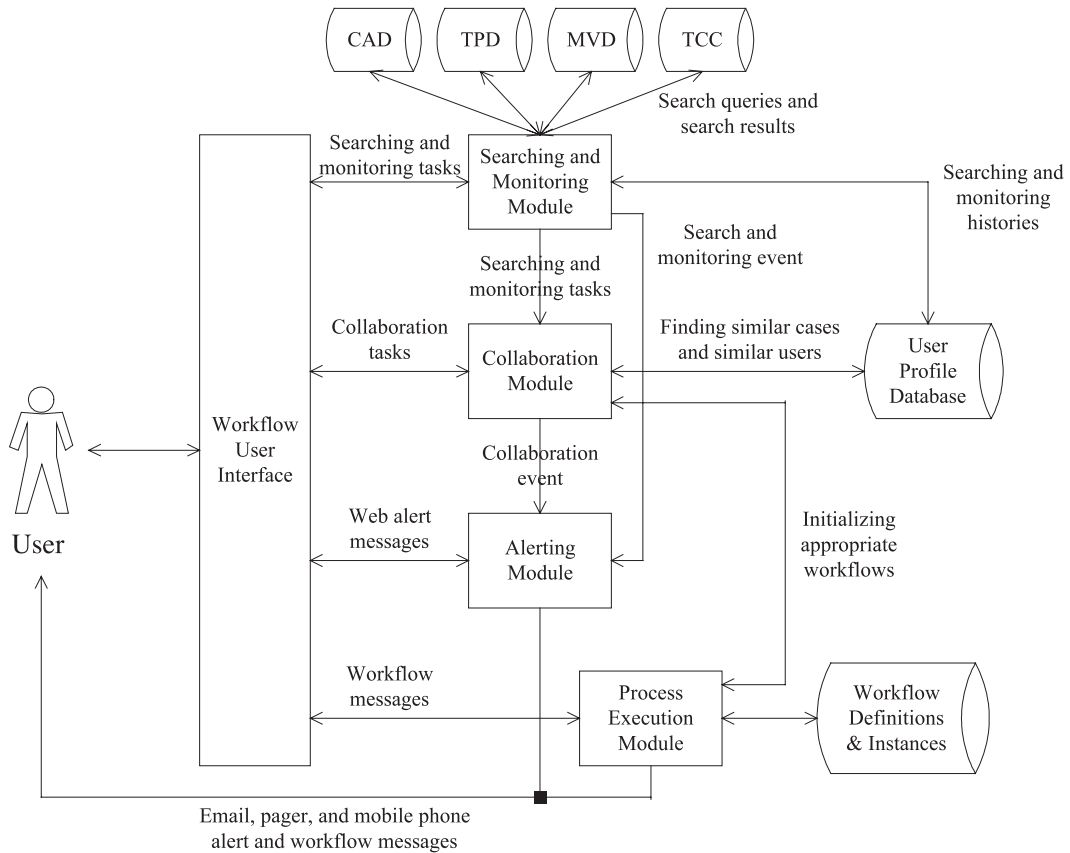

Fig. 7. System architecture of COPLINK workflow.

keeping a list of monitoring tasks for each user, and performing these tasks periodically based on the user's preference. The collaboration module facilitates the sharing of information among different users. These two modules implement the main functionality of the consultation workflow as illustrated in Fig. 4. The alerting module is responsible for keeping track of the messages for each user and delivering these messages through different communications channels. The alerting module implements part of the functionality of the case alert workflow as shown in Fig. 6. The personalization module keeps track of each user's search history and allows the user to customize various system settings. Although the task assignment and negotiation module has not yet been implemented, the collaboration module already provides the basic information access and matching capabilities needed to implement it. The process execution module is responsible for monitoring and controlling various

workflow processes and interacting with the law enforcement personnel to execute the crime analysis workflows presented previously. The functionalities of the main modules of COPLINK workflow are described briefly below.

#### 4.2. Main functionalities of COPLINK workflow

##### 4.2.1. Searching and monitoring module

The searching and monitoring module accepts search queries from users and forwards them to the corresponding data sources. In addition to the COPLINK database for the Tucson Police Department (TPD) data used in COPLINK Connect, the searching and monitoring module connects to three additional data sources: the Computer Aided Dispatch (CAD) database used at TPD, the Motor Vehicle Division (MVD) database in the state of Arizona, and the Tucson City Court (TCC) Web-based search engine. These

databases provide additional person, location and vehicle information that are not available in the COPLINK database. In addition to the search functionalities, this module also allows users to set up monitoring tasks for the available data sources. For instance, if a user wants to monitor all four data sources for a particular query, the monitor task will be stored in the user profile database and the data sources will be automatically monitored for changes.

#### 4.2.2. Collaboration module

To facilitate collaboration among law enforcement personnel, we developed a collaborative filtering module based on users' search actions and search histories. The rationale behind this design is that when two users search for the same information in criminal databases, it is likely that the users have similar information needs and that they may possibly be working on two related cases. By storing and analyzing user search histories, the collaboration module facilitates such collaboration in two different ways. First, when a user performs a search, the collaboration module can instantly identify other users who have performed a similar search in the past. For example, if a detective runs a search on a particular suspect, he or she can also view all the other users who have searched information about this suspect. Second, the user also can specify whether he/she wants to be notified when some other users perform a similar search in the future. When this happens, the collaboration module will notify both users through the alerting module. The users can then contact each other to determine whether they have any information to share. Currently, we consider two searches to be similar only if the search query terms match exactly with each other. Other matching algorithms can be easily added and will be pursued in our future research.

It should be noted that COPLINK workflow has an underlying agent architecture similar to Ref. [8]. In terms of user profiles, COPLINK workflow makes use of the information monitoring conditions that the users entered into the system and can be seen as a special type of expertise recommender system as proposed by Ref. [11].

#### 4.2.3. Alerting module

The alerting module manages all the alert messages that should be sent to a user. Whenever a user sets up a

task in the searching and monitoring module or the collaboration module that may result in future alerting messages, the user can specify how he/she wants to be notified. When an alerting condition is satisfied, the alerting module will receive the alerting messages from the collaboration and search modules. The messages will then be saved in the database and delivered to the user via the communications channel specified. Currently, messages can be sent to a user instantly through e-mail, pager and mobile phone. If the user is currently logged on the system, the message also can be presented through the COPLINK workflow interface.

#### 4.2.4. Process execution module

The process execution module implements the necessary functions for monitoring and controlling the various crime analysis workflows such as those described previously. Note that the other modules in the COPLINK workflow can initiate a workflow when appropriate. For instance, the alerting module is the most likely module to initiate a case alert workflow as specified in the previous section. Once a workflow is initiated, the process execution module takes over by keeping track of the progress of a specific workflow instance and interacting with the relevant personnel to complete the tasks as defined by the workflow template. The process execution module also allows the abortion of a workflow instance when needed if the host of a workflow instance determines that the workflow is no longer needed. The interactions with the personnel can be done through the workflow user interface or through other communication devices such as email, pager and mobile phone.

Suppose the user wants to perform a search for a person, he or she can click on the tab "perform new search" in COPLINK workflow. Currently, four types of searches are implemented, namely "person/organization search", "vehicle search", "location search" and "incident search". All the search forms have a similar layout while each form has its specific search fields. Person search is used in our example. After the user clicks on "person search", the corresponding search form will be shown (see Fig. 8). This search form is divided into the following five input areas:

- (1) Database selection: this area allows the user to select which data sources are to be searched. In the example shown in Fig. 8, the TPD database

ALERTS Hello! JDOE

**New Person Search**

Database Selection:  CAD  TPD  MVD  TCC

Name: Last/Organization: Sejkora First: Jason Role: All Roles

YYYYMMDD

DOB: Phone: ( ) - -

Mug#: SSN: - -

OLN: SID#:

FBI#:

**Alerting Methods**

Whether to be notified when others do a similar search

Do not notify me.

Notify me, if anyone in Narcotics performs the same search.

Notify me, if anyone performs the same search.

**Collaboration Settings**

Specify the ways you want to be notified

Email: officer430@yahoo.com

Pager:

Cellular Phone: 5208412740

Voice Message:

Web Messages

Whether to let others know you have done this search

Others cannot see my search.

Anybody in Narcotics can see my search.

Everybody can see my search.

Notes for future retrieval

Place for relevant info

Search according to the above query

List other officers who did the same search

Search List Reset

**Instant Collaboration**

Fig. 8. Person search and monitoring screen in COPLINK workflow.

- and the Tucson City Court (TCC) records are chosen by the user as the information sources.
- (2) Search fields: the user can then enter the specific searching criteria. For instance, if the user wants to search for the records of a person named “Jason Sejkora”, the user will enter “Jason” in the first name field and “Sejkora” in the last name field.
  - (3) Collaboration settings: in the upper portion of this input area, the user can choose the “notification level” of the search. The user can choose to be notified when anyone performs the same search, when anyone in the specified police unit performs the same search, or not to be notified at all. In the lower portion, the user can choose the “confidentiality level” of the

search. The user can choose to make the search performed visible to all other users, only to users in the same police unit, or to nobody at all. In this example, the user chooses to be notified if any other user performs the same search. The user also chooses to make this particular search visible to all other users.

- (4) Alerting methods: this area allows the user to specify how he or she wants to be notified if there are some other users who have performed the same search. The user can choose from multiple notification methods including Web messaging, e-mail and cellular phone messages.
- (5) Notes: the user can enter some additional information in this area relevant to the search. The notes will be displayed in the alert messages.

After providing all the information, the user performs a search by clicking the “Search” button at the bottom of the search form. The search query is then forwarded to the specified database(s) and the search results are displayed to the user. When the number of the returned records is large, the user can click on the heading of any column to sort the records based on that column. In addition, before performing the search, the user can also click on the “list” button to see whether any other user has performed the same search before. This is referred to as the “instant collaboration” function. After showing all the users who have performed the same search in the past, the system allows the user to click on the user name to retrieve their contact information in case direct communication with them is desired.

#### 4.3. Summary of a pilot evaluation study

Our study follows the systems development methodology proposed in [14], which stresses the close links between systems development activities, theory building and systems evaluations in both research and practice. Our methodology for evaluating COPLINK workflow is a case study method incorporating structured interviews, usability surveys and archival records analysis (e.g., summary of user-added monitoring tasks and the alerts produced by the system). To select the required usability evaluation techniques, we first identified two usability goals and the three dimensions of usability. The resulting usability metrics encompassing the specific measures and techniques used is shown in Table 2.

The structured interviews for the pilot users were guided by the COPLINK workflow system log files which include lists of monitoring profiles that the pilot users added into the system, as well as the alerts that the users received after matches are found. The subjective measure of user satisfaction was evaluated

using a standard usability survey instrument. User comments for database monitoring and collaboration functions were also collected, along with suggestions for interface and functionality improvements. Lastly, the qualitative data obtained from the interview sessions was triangulated with the quantitative results from the alert log ratings and usability surveys.

Fifteen detectives from the Tucson Police Department’s Criminal Investigation Division (CID) were recruited to evaluate the COPLINK workflow system from June to August 2002. Participants who received alerts were given listings of the alerts and were asked to rate the usefulness of each alert. Based on the alert ratings and the list of monitoring tasks, a user was asked to provide his or her subjective rating of the alerts received, along with other relevant contextual information including: the nature/type of the case, the search parameters in which a user is interested (last name, first name, day of birth, race, sex, etc.), the reasons behind adding a monitoring profile, the usefulness of the alert messages received by the users if there is any and if there is any follow-up done by the user for a particular alert. Participants were also asked to rate the effectiveness and efficiency of database monitoring and collaboration functions, as well as desired new functionalities. Suggestions for improving current functions and interface were also collected. To gauge subjective user satisfaction, we adopted the QUIS instrument as reported by Chin et al. [7] and added sections to gauge the effectiveness and efficiency of the collaboration, monitoring and alerting functions. Our QUIS questionnaire items appear in Appendix A.

During our 3-month testing period, a user, on average, received 5.5 alerts/month. Out of those alerts received, approximately 32% of them were rated equal or above “somewhat useful” on our scale. The user’s subjective ratings of the alerts also averaged 5.5 out of a 7-point scale (with 7 being the most useful), suggesting a relatively high user satisfaction.

Table 2  
Usability metrics of COPLINK workflow usability evaluation

Usability objective	Effectiveness measures	Efficiency measures	Satisfaction measures
Suitability for investigative tasks	Percentage of alerts deemed useful (archival data+interview)	Time required to create a new monitoring profile (interview)	Rating scales for overall usability (survey)
Learnability	Percentage of functions learned (survey)	Time to learn criteria (interview)	Rating scales for ease of learning (survey)

The most typical reasons that users add monitoring tasks include: (1) person monitoring: monitoring a suspect, a witness, or an informant, or someone who is on parole; (2) address monitoring: monitoring the exact address or the address of the apartment complex of a suspect; (3) license plate monitoring: monitor a specific car whose license plate number is of interest to the detectives. As to the monitoring and collaboration functionalities, users were generally pleased with the system's capabilities for assisting criminal investigations. In terms of overall effectiveness, the initial implementation of COPLINK workflow also garnered positive feedback. The short-form of the QUIS instrument averaged 5.5 for 27 items on a 7-point Likert scale with 7 being most useful. A profile analysis reveals the weaknesses of COPLINK workflow including lack of help messages, difficult for inexperienced users and obscure user preference settings. The identified strengths of COPLINK agent include: offering good investigative power, easy to read layout, potential for collaborative information sharing, CAD Integration, as well as high intention to use. We were able to use the feedback on the user satisfaction to create a list of system enhancements that we plan to implement in the next phase of the COPLINK workflow development. During the user evaluation, we also noted that in order to harness the full potential of COPLINK workflow's advanced information monitoring/filtering functionalities, the databases monitored by COPLINK workflow need to be checked on a near real-time basis. The current implementation checked data sources for updates on a daily basis because CAD data updates were imported into the main TPD database once a day; most pilot users expressed interest in significantly increased database monitoring frequency (e.g., hourly). Some user comments in this regard include: "The only other improvement I could ask for would be it query a couple times a day as opposed to once every 24 hours" and "Detective could have been dispatched immediately, if notification had been in real time".

The pilot evaluation study described above serves its purposes of (a) confirming our hypothesis concerning the usefulness of process-driven support for intra-organizational collaboration, and (b) generating specific suggestions for improvements and user feedback on COPLINK workflow implementation. We caution the reader, however, about the preliminary nature of this study. To ensure the external

validity of our research findings, a more complete evaluation study involving a larger number of subjects using the production-grade, fully-implemented COPLINK workflow system is necessary. Such a large-scale evaluation study is planned for future research.

## 5. Conclusions

In this paper, we have investigated the needs of intra-agency collaboration support through a field study and proposed a process-driven approach based on workflow technology. We have also presented a prototype system called COPLINK workflow, which implements some of the key collaboration support functions identified. Initial user evaluation shows promising evidence for the positive impact that process-driven collaboration support can have on the overall effectiveness and efficiency of the crime analysis process.

We are currently pursuing two lines of research. The first involves further extending the functionalities of COPLINK workflow to encompass all the collaborative workflows identified in this paper since the current implementation only covers a subset of the workflow functions. In particular, we will focus on task assignment and negotiation issues arisen in crime-fighting related workflows [20]. In addition, the current implementation of COPLINK workflow is based on a home-grown process management framework. It contains pre-designed collaboration workflows presented previously but does not support dynamic workflow reconfiguration or permit easy incorporation of new workflow types. We are investigating the possibility of using a commercial workflow management system to provide more general and flexible process management support. The second line of research concerns the development of collaboration support mechanisms that can go beyond organizational boundaries. Most existing law enforcement information systems are developed and deployed by individual agencies operating at the regional, state or national level [13]. How to enable collaboration across organizations poses many technological and organizational challenges [3]. Our future work will address these challenges by applying inter-organizational workflow technologies [19].

**Appendix A. QUIS instrument for measuring user satisfaction of COPLINK workflow**

<i>A. Overall reactions towards COPLINK workflow</i>			
(Wonderful/terrible)	wonderful	1 2 3 4 5 6 7	terrible
(Satisfying/frustrating)	satisfying	1 2 3 4 5 6 7	frustrating
(Stimulating/dull)	stimulating	1 2 3 4 5 6 7	dull
(Easy/difficulty)	easy	1 2 3 4 5 6 7	difficult
(Adequate power/inadequate power)	adequate power	1 2 3 4 5 6 7	inadequate power
(Flexible/rigid)	flexible	1 2 3 4 5 6 7	rigid
<i>B. Screen layout and sequence of COPLINK workflow</i>			
Characters on the computer screen (easy/hard to read)	easy	1 2 3 4 5 6 7	hard
Highlighting on the screen simplifies task	very much	1 2 3 4 5 6 7	not at all
Organization of information on screen	very clear	1 2 3 4 5 6 7	confusing
Sequence of screens	very clear	1 2 3 4 5 6 7	confusing
<i>C. Terminology and system information in COPLINK workflow</i>			
Use of terms throughout system	consistent	1 2 3 4 5 6 7	inconsistent
Computer terminology is related to the task	always	1 2 3 4 5 6 7	never
Position of messages on screen	consistent	1 2 3 4 5 6 7	inconsistent
Messages on screen which prompt user for input	clear	1 2 3 4 5 6 7	confusing
Computer keeps you informed about what it is doing	always	1 2 3 4 5 6 7	never
Error messages	helpful	1 2 3 4 5 6 7	unhelpful
<i>D. Learning to use COPLINK workflow</i>			
Learning to operate the system	easy	1 2 3 4 5 6 7	difficult
Exploring new features by trial and error	easy	1 2 3 4 5 6 7	difficult
Remembering names and use of commands	easy	1 2 3 4 5 6 7	difficult
Tasks can be performed in a straightforward manner	always	1 2 3 4 5 6 7	never
Help messages on the screen	helpful	1 2 3 4 5 6 7	unhelpful
Supplemental reference materials	clear	1 2 3 4 5 6 7	confusing
<i>E. System capabilities of COPLINK workflow</i>			
System speed	fast enough	1 2 3 4 5 6 7	too slow
System reliability	reliable	1 2 3 4 5 6 7	unreliable
System tends to be	quiet	1 2 3 4 5 6 7	noisy
Correcting your mistakes	easy	1 2 3 4 5 6 7	difficult
Experienced and inexperienced users' needs are taken into consideration	always	1 2 3 4 5 6 7	never
<i>F. Collaboration functionality of COPLINK workflow</i>			
Notifications of other officers' performing the same searches help me to solve cases.	agree	1 2 3 4 5 6 7	disagree
Notifications of other officers' performing the same searches help me solve cases in less time.	agree	1 2 3 4 5 6 7	disagree
COPLINK workflow facilitates collaboration in the area of criminal information sharing.	agree	1 2 3 4 5 6 7	disagree
<i>G. Monitoring functionality of COPLINK workflow</i>			
Notifications of changes in the database helps me solve cases.	agree	1 2 3 4 5 6 7	disagree
Notifications of changes in the database helps me solve cases in less time.	agree	1 2 3 4 5 6 7	disagree
I often select individual records for monitoring.	agree	1 2 3 4 5 6 7	disagree
<i>H. Alerting functionality of COPLINK workflow</i>			
The information provided in the e-mail alerts are sufficient to help me in my work.	agree	1 2 3 4 5 6 7	disagree
I often elect to select more than one alerting methods to receive notifications.	agree	1 2 3 4 5 6 7	disagree

(continued on next page)

## Appendix A (continued)

### I. Overall assessment and usage intention of COPLINK workflow

Generally, the notifications I receive from COPLINK workflow are helpful.	agree	1 2 3 4 5 6 7	disagree
Adding monitor tasks does not require a lot of mental effort.	agree	1 2 3 4 5 6 7	disagree
Overall, I am satisfied with COPLINK workflow.	agree	1 2 3 4 5 6 7	disagree
Given that I have access to COPLINK workflow, I intend to use it for my tasks in the future.	agree	1 2 3 4 5 6 7	disagree

## References

- [1] R.W. Adderley, P. Musgrove, Police crime recording and investigation systems—a user's view, *Policing: An International Journal of Police Strategies & Management* 24 (1) (2001) 100–114.
- [2] K.M. Anderson, A. Andersen, N. Wadhvani, L.M. Bartolo, Managing resources and services: metis: lightweight, flexible, and web-based workflow services for digital libraries, *Proceedings of the third ACM/IEEE-CS joint conference on Digital libraries*, 2003.
- [3] H. Atabakhsh, C. Larson, T. Petersen, C. Violette, H. Chen, Information sharing and collaboration policies within government agencies, *Proceedings of the Second Symposium on Intelligence and Security Informatics*, 2004.
- [4] I. Becerra-Fernandez, Locating expertise at NASA, *Knowledge Management Review* 4 (4) (2001) 34–37.
- [5] H.H. Bi, J.L. Zhao, Mending the lag between commercial needs and research prototypes: a logic-based workflow verification approach, *Proceedings of The 8th INFORMS Computing Society Conference*, 2003.
- [6] H. Chen, D. Zeng, H. Atabakhsh, W. Wyzga, J. Schroeder, COPLINK: managing law enforcement data and knowledge, *Communications of the ACM* 46 (1) (2003 January) 28–34.
- [7] J.P. Chin, V.A. Diehl, K.L. Norman, Development of an instrument measuring user satisfaction of the humancomputer interface, *Proceedings of the ACM CHI '88*, ACM Press, Washington, DC, 1988, pp. 213–218.
- [8] R. Crowder, G. Hughes, W. Hall, Approaches to locating expertise using corporate knowledge, *International Journal of Intelligent Systems in Accounting, Finance & Management* 11 (2002) 185–200.
- [9] C.Y. Kou, An evaluation for nation wide police information system (NWPIS) based on internet, *Proceedings of the 32nd Annual International Carnahan Conference on Security Technology*, IEEE Press, 1998, pp. 117–120.
- [10] P.K. Manning, Information technology in the police context: the “sailor” phone, *Information Systems Research* 7 (1) (1996) 52–62.
- [11] D.W. McDonald, M.S. Ackerman, Expertise recommender: a flexible recommendation system and architecture, *Proceedings of 2000 ACM Conference on Computer Supported Cooperative Work*, ACM Press, Philadelphia, PA, 2000, pp. 231–240.
- [12] M. McKay-Smith, A.C. Gustin, Forms control and design in a small police department, *ARMA Records Management Quarterly* 16 (1) (1982) 7–8.
- [13] A. Northrop, D. Dunkle, K.L. Kraemer, J.L. King, Computers, police, and the fight against crime: an ecology of technology, training and use, *Informatization and the Public Sector* 3 (1) (1994) 21–45.
- [14] J. Nunamaker, M. Chen, T. Purdin, Systems development in information systems research, *Journal of Management Information Systems* 7 (3) (1991) 89–106.
- [15] B.W. Simms, E.R. Petersen, An information processing model of a police organization, *Management Science* 37 (2) (1991) 216–232.
- [16] E.A. Stohr, J.L. Zhao, Workflow automation: overview and research issues, *Information Systems Frontiers: Special Issue on Workflow Automation and Business Process Integration* 3 (3) (2001 September) 281–296.
- [17] J.A. Taylor, H. Williams, Police management office automation and organizational change, *New Technology, Work and Employment* 7 (1) (1992) 44–53.
- [18] M.A.P. Willmer, An information-theoretic approach to the organization of police forces, current topics in cybernetics and systems, *Proceedings of the 4th International Congress of Cybernetics & Systems*, Springer-Verlag, Berlin, 1978, p. 298.
- [19] D. Zeng, J.L. Zhao, Achieving software flexibility via intelligent workflow techniques, *Proceedings of the 35th Hawaii International Conference on System Sciences*, 2002.
- [20] D. Zeng, J.L. Zhao, Effective role resolution in workflow management, *INFORMS Journal on Computing* (2004) (in press).



J. Leon Zhao is Honeywell Fellow and Associate Professor of MIS, University of Arizona. He holds PhD degree from University of California, Berkeley, MS degree from University of California, Davis, and Bachelor's degree from Beijing Institute of Agricultural Mechanization. He has previously taught in Hong Kong University of Science and Technology and College of William and Mary. He has published in *Management Science*, *Information Systems Research*, *Communications of the ACM* and *Journal of Management Information Systems*. He is Associate Editor for *Electronic Commerce Research and Applications* and *International Journal of Web Services Research* and serves on the Editorial Board of *Journal of Database Management*. He is Co-chair of the Second Workshop on e-Business, 2003.



Henry Haidong Bi is assistant professor in the Department of Supply Chain and Information Systems at the Pennsylvania State University. His current research interests include business process management (modeling, verification, mining, and optimization) and workflow technologies. He received his PhD degree in Management Information Systems from the University of Arizona, MBA from Rochester Institute of Technology, and BE in Mechanical Engineering from Shanghai Jiao Tong University, Shanghai, China. His research work has appeared in Information Technology and Management and international conferences.



Hsinchun Chen is McClelland Professor of MIS and Director of the Artificial Intelligence Lab and Hoffman E-Commerce Lab at the University of Arizona. He received his PhD in Information Systems from New York University in 1989. He has been heavily involved in fostering digital library, medical informatics, and knowledge management research and education in the US and internationally. He is a Scientific Counselor of the Lister Hill Center of National Library of Medicine, USA. Dr. Chen is an Associate Editor of *Decision Support Systems*, *Journal of the American Society for Information Science and Technology*, and *ACM Transactions on Information Systems*. Dr. Chen developed the internationally acclaimed COPLINK system, which has become a national (and international) model for law enforcement and intelligence data sharing and mining. He is author of more than 120 refereed articles covering knowledge management, data and text mining, medical informatics, homeland security, intelligence analysis and Web computing. Dr. Chen has served as the Conference/Program Co-chair for the past five International Conferences of Asian Digital Libraries (ICADL). He is also Conference Co-chair of ACM/IEEE Joint Conference on Digital Libraries (JCDL) 2004 and the first NSF/NIJ Symposium on Intelligence and Security Informatics (ISI 2003). Dr. Chen is also a recognized advisor for international IT research programs in Asia and Europe.



Daniel Dajun Zeng is Assistant Professor and Honeywell Fellow in the Department of Management Information Systems at the University of Arizona. His research interests include software agents and their applications, distributed artificial intelligence, distributed optimization, computational support for auctions and negotiations, intelligent information integration and caching, and recommender systems. He has co-edited two books and published about 50 peer-reviewed articles in Management Information Systems and Computer Science journals, edited books and conference proceedings. He is currently directing four NSF-funded research projects as PI or co-PI. He received MS and PhD degrees in industrial administration from Carnegie Mellon University, and a BS in Economics and Operations Research from the University of Science and Technology of China, Hefei, China. He is a member of INFORMS, AAAI, ACM and IEEE.

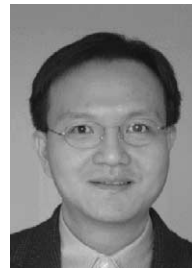

Chienting Lin is Assistant Professor of Information Systems at Pace University, New York City. He received his Ph.D. in Management Information Systems from the University of Arizona. His major research interests include technology adoption and diffusion, network information assurance and security, electronic commerce, knowledge management systems and implementations of enterprise systems. His research work has appeared in the *Journal of Management Information Systems*, *IEEE Transactions on Pattern Analysis and Machine Intelligence*, *Social Science Computer Review*, *Hawaii International Conference on System Sciences*, *ACM Digital Library Conference*, *National Conference on Digital Government Research*, and *NSF/NIJ Symposium on Intelligence and Security Informatics*.



Michael Chau is currently a Research Assistant Professor in the School of Business at the University of Hong Kong. He received his PhD degree in Management Information Systems from the University of Arizona and a Bachelor's degree in Computer Science (Information Systems) from the University of Hong Kong. When at Arizona, he was an active researcher in the Artificial Intelligence Lab, where he participated in several projects funded by NSF, NIH, NIJ and DARPA. His current research interests include information retrieval, Web mining, knowledge management, intelligent agents and security informatics.